

Produktový list

Objednací kód: **FL1690L**

FORTIS EDGE sprchové dveře do niky 900mm, čiré sklo, levé

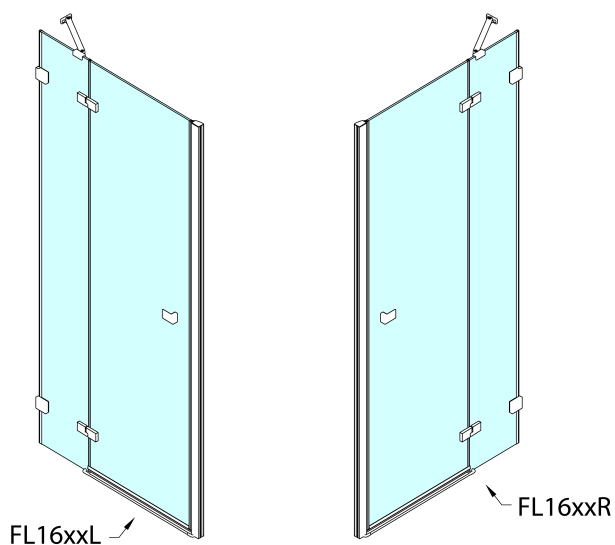

	A (mm)	B (mm)
FL1680	790-805	≈ 190
FL1690	890-905	≈ 290
FL1610	990-1005	≈ 390
FL1611	1090-1105	≈ 490
FL1612	1190-1205	≈ 590

CZ: Stavební připravenost pro montáž na dlažbu kóty A= vzdálenost mezi zdmi.

EN: Construction readiness for floor mounting dimension A= distance between walls.

